



To download the full installation and user manuals and register your product, please visit:
www.DSC.com/m/29009534 or scan the QR code to the right.



HS2016/HS2016-4/HS2032/HS2064/HS2064 E/ HS2128/HS128 E Alarm Panel V1.2 User Guide



WARNING: This manual contains information on limitations regarding product use and function and information on the limitations as to liability of the manufacturer. The entire manual should be carefully read.

Table of Contents

1.0 Quick Reference	3
2.0 Understanding Your Keypad	5
2.1 Icon and LED Keypad Symbols	5
2.2 Keypad Models	6
3.0 The PowerSeries Neo Security System	7
3.1 General System Operation	7
3.2 Testing Your System	7
3.3 Monitoring	8
3.4 Maintenance	8
4.0 Arming the System	9
4.1 Arming the System (Infinite Exit Delay)	9
4.2 Away Arming the System with the Keypad	9
4.3 Exit Delay Time Restart	10
4.4 Alarm Cancel Window	10
4.5 Using 2-way Wireless Keys and Proximity Tags	10
4.5.1 Arming the System with a 2-Way Wireless Key	11
4.5.2 Arming the System with a Proximity Tag	11
4.6 Disarming the System	11
4.6.1 Disarming Error	11
5.0 Emergency Keys	12
6.0 Access Code Types	13
6.1 Adding, Changing and Deleting Access Codes	14
6.2 Burglary Verification	15
6.3 Swinger Shutdown	15
6.4 Call Waiting	15
6.5 Fire Alarm Verification	15
6.6 System Lockout due to Invalid Attempts	15
6.7 User Labels (LCD keypads only)	15
7.0 Trouble Conditions	17
8.0 Safety Instructions	22
8.1 Regular Maintenance and Troubleshooting	22
8.1.1 Cleaning and Maintenance	22
9.0 EULA	24
10.0 Installer Warning	26
11.0 Reference Sheets	28
11.1 System Information	28
11.2 Service Contact Information	28
12.0 Access Code and Sensor/Zone information	29
13.0 Locating Detectors and Escape Plan	32
13.1 Smoke Detectors	32
13.2 Fire Escape Planning	33
13.3 Carbon Monoxide Detectors	34
14.0 Regulatory Agency Statements	35

1.0 Quick Reference













The PowerSeries Neo Alarm System uses shortcut keys to access options or features on all models of keypads. When using an LCD keypad, the PowerSeries Neo Alarm System additionally uses a menu based navigation system. The scroll keys can be used to [Scroll] through the list of options contained within the current menu. For more information on keypads see: 2.0 “Understanding your Keypad”. Lookup detailed information on any of the listed actions using the accompanying Section number.



For detailed information about the PowerSeries Neo Alarm System, refer to the full online manual, which can be accessed from the DSC.com Web site.









Note: Some features must be enabled by installer.

Note: Bypass Groups are not permitted in UL listed installations.

Note: [*] - If configured by installer.

Status Lights	Function Keys	Function Keys	Status Lights	Emergency Keys	Emergency Keys
	Ready - Indicates system normal. Must be on to arm system. All zones must be secured or bypassed and the system disarmed for this light to activate.		Stay Arm		Fire Alarm
	Armed- Indicates system is armed . If the Ready light and the Armed light are both on, an Exit Delay is in progress.		Away Arm		Medical Alarm
	Trouble - On indicates a system malfunction or tamper. Flashing indicates that the keypad has a low battery condition. Follow the instructions displayed or enter [*][2] to view trouble. Correcting the trouble turns off the indicator.		Chime		Panic Alarm
	AC Power - Indicates AC Power is present. The AC Power light will turn off when AC is absent.		Reset Sensors		
			Quick Exit		

Action	Press
Away Arm	 for 2 seconds + [Access Code*]
Stay Arm	 for 2 seconds + [Access Code*]
Night Arm	When armed in stay mode [*][1] + [Access Code*]
Disarm	[Access Code]
No-Entry Arming	[*][9] + [Access Code*]
Quick Arm /Quick Exit	[*][0]
Abort Arming Sequence	[Access Code]
Bypassing - All bypass commands begin with [*][1] + [Access Code*]	

Action	Press
Bypass Individual Zones	[3 Digit Zone #]
Bypass All Open Zones	[9][9][8]
Recall Last Bypass	[9][9][9]
Clear Bypass	[0][0][0] OR [Scroll] Bypass Options + [*] + [Scroll] Clear Bypasses + [*]
Program Bypass Group	[3 digit zone #s] + [9][9][5] OR [3 digit zone #s] + [Scroll] Bypass Options + [*] + [Scroll] Prg Bypass Group + [*]
Load Bypass Group	[9][9][1] OR [Scroll] Bypass Options + [*] + [Scroll] Bypass Group + [*]
Common Functions	
Set Time and Date	[*][6] [Master Code] + [0][1]
Turn Chime ON/OFF	[*][4] + [Access Code*] OR 
Change Brightness	[*][6] [Master Code] + [1][2] + 
Change Contrast	[*][6] [Master Code] + [1][3] + 
Add/Delete User	[*][5] + [Master Code] + [Access Code] + 1
Reset Smoke Detectors	 OR [*][7][2]
View Troubles	[*][2] + [Access Code*] + 
View Alarms	[*][3] + [Access Code*] + 
Perform System Test	[*][6] + [Master Code] + [0][4] + 
Buzzer Volume	[*][6] + [Master Code] + [1][4] + 

2.0 Understanding Your Keypad

The PowerSeries Neo Alarm System supports a variety of wireless, hardwired and proximity sensor LCD, LED and Icon keypads. All keypads come equipped with the LED status lights described in section 1 "Quick Reference". HS2LCD series keypads display system messages on their LCD screen. HS2ICN series keypads display messages, as described in the following section. HS2LED series keypads display messages via a series of numbered LEDs, as described in the following section. All keypad versions will have a solid blue LED bar that is always on steady except when, if enrolled, a proximity tag is presented to and successfully read by the keypad.

2.1 Icon and LED Keypad Symbols

HS2ICN Series

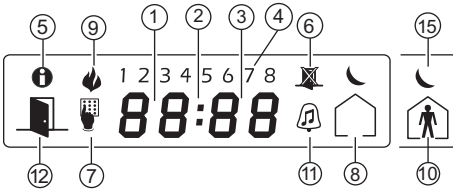

HS2LED Series

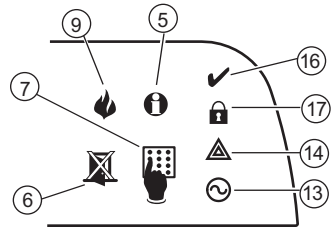

- | | |
|---|---|
| <ol style="list-style-type: none"> 1. Clock Digits 1, 2 2. : (Colon) 3. Clock Digits 3, 4 4. 1 to 8 5. Memory 6. Bypass 7. Program 8. Away 9. Fire 10. Stay | <p>These two 7 segment clock digits indicate the hour digits when the local clock is active. Digit 2 is also used to identify the zone number as the 1 when the zone number is 100 or higher and the OPEN or ALARM icons are active.</p> <p>This icon is the hours/minutes divider and will flash once per second when the local clock is active.</p> <p>These two 7 segment displays are the minute digits when the local clock is active. The digits 3 and 4 are used to indicate the zone number for open zones or alarm in memory. These two digits combined with the clock digit 2, scroll one zone per second from the lowest number to the highest, when scrolling through zones.</p> <p>These numbers identify troubles when [*][2] is pressed.</p> <p>Indicates that there are alarms in memory.</p> <p>Indicates that there are zones bypassed.</p> <p>Indicates that the system is in Installer or User's programming, or that the keypad is busy, and the LED will flash in cadence of 250ms ON and 250ms OFF. If Access Code is required, while accessing star menus, this LED is ON and solid to indicate that the code is required.</p> <p>Indicates that the panel is armed in the Away Mode.</p> <p>Indicates that there are fire and/or CO alarms in memory.</p> <p>Indicates that the panel is armed in the Stay Mode.</p> |
|---|---|

- | | |
|-------------------------|--|
| 11. Chime | This icon turns on when the Chime function key is pressed to enable Door Chime on the system. It will turn off when the chime function key is pressed again to disable Door Chime. |
| 12. OPEN | This icon is used with clock digits 1 and 2 to indicate activated zones (not alarm) on the system. When zones are opened, the OPEN icon will turn on, and 7 segment displays 1 and 2 will scroll through the violated zones. |
| 13. AC | Indicates that AC is present at the main panel. |
| 14. System Trouble | Indicates that a system trouble is active. |
| 15. Night | Indicates that the panel is armed in the Night Mode. |
| 16. Ready Light (green) | If the Ready light is on, the system is ready for arming. If the toggle of the Ready LED flashes for Force Arming enabled, the LED flashes with force armable zones open on the partition. |
| 17. Armed Light (red) | If the Armed light is on, the system has been armed successfully. |

Note: For UL listed installations, zones can only be bypassed manually.

2.2 Keypad Models

Note: In the following list if x = 9 (the system operates in 912-919MHz), x=4 (the system operates in 433MHz band) or x=8 (the system operates in 868MHz band). Only models operating in 912-919MHz band are UL/ULC listed.

HS2LCD	Alphanumeric LCD keypad
HS2LCDP	Alphanumeric LCD keypad with Prox. Tag support
HS2ICN	Icon keypad
HS2ICNP	Icon keypad with Prox. Tag support
HS2LED	LED keypad
HS2LCDRFx	Alphanumeric LCD keypad with wireless receiver
HS2LCDRFPx	Alphanumeric LCD keypad with wireless receiver and Prox. tag support
HS2ICNRFx	Icon keypad with wireless receiver
HS2ICNRFPx	Icon keypad with wireless receiver and Prox. tag support
HS2LCDWFx	Wireless Alphanumeric LCD keypad
HS2LCDWFPx	Wireless Alphanumeric LCD keypad with Prox. Tag support
HS2LCDWFVPx	Wireless Alphanumeric LCD keypad with Prox. Tag support & Voice Prompt
HS2TCHP	Touchscreen keypad. For additional information, refer to the HS2TCHP Touchscreen User Manual; part #: 29009478R001.

Note: For systems compliant with EN50131-1 and EN50131-3 the HS2LED keypad shall be used in conjunction with an LCD type keypad (HS2LCD(P) or HS2LCDRF(P)8 or HS2LCDWF(P)8 in order to be able to review logged events and also to allow overriding of conditions that inhibit setting of the alarm system. The HS2LED keypad alone cannot support these functions.

3.0 The PowerSeries Neo Security System

Your PowerSeries Neo has been designed to provide you with the greatest possible flexibility and convenience. Read this manual carefully and have your installer instruct you on how to operate your system and which features have been implemented in your system. All users of this system should be equally instructed in its use. Fill out section "System Information" with all of your zone information and access codes and store this manual in a safe place for future reference.

Note: The PowerSeries Neo security system includes specific false alarm reduction features and is classified in accordance with ANSI/ SIA CP-01-2010 Control Panel Standard - Features for False Alarm Reduction. Please consult your installer for further information regarding the false alarm reduction features built into your system as all are not covered in this manual.

3.1 General System Operation

Your security system is made up of a PowerSeries Neo control panel, one or more keypads and various sensors and detectors. The control panel will be mounted out of the way in a utility closet or in a basement. The metal cabinet contains the system electronics, fuses and standby battery. All the keypads have an audible indicator and command entry keys. LED keypads have a group of zone and system status lights. LCD keypads have an alphanumeric liquid crystal display (LCD). The keypad is used to send commands to the system and to display the current system status. The keypad(s) will be mounted in a convenient location inside the protected premises close to the entry/exit door(s). The security system has several zones of area protection and each of these zones is connected to one or more sensors (motion detectors, glassbreak detectors, door contacts, etc.). A sensor in alarm is indicated by the corresponding zone lights flashing on an LED keypad or by messages on the LCD keypad.

Note: Only the installer or service professional shall have access to the control panel.

3.2 Testing Your System

Tests all system keypad LEDs, keypad sounders, bells and/or sirens.

To ensure that your system continues to function as intended, you must test your system weekly.

IMPORTANT: For UL HOME HEALTH CARE listed applications the system shall also be tested weekly without AC power. To remove AC from the control unit, remove the screw from the restraining tab of the plug in adapter and remove the adapter from AC outlet. After completing the test of the unit using only the battery backup source, reconnect the plug in adapter and attach the screw through the restraining tab so that the adapter is securely attached to the outlet.

IMPORTANT: Should your system fail to function properly, contact your installation company.

IMPORTANT: All smoke detectors must be tested by your smoke detector installer once per year.

To Perform a Keypad and Siren Test

LCD Display

1. From the Ready state press [*][6] and enter the [Master Code] to access User Functions.
2. Press [04] or use the scroll keys to navigate to System Test and press [*]. The system activates all keypad sounders, bells/sirens and keypad LEDs for two seconds.
3. To go back to the Ready state press [#].

Press (*) for <> User Functions

Press (*) for <> System Test

3.3 Monitoring

This system is capable of transmitting alarms, troubles and emergency information. If you initiate an alarm by mistake, immediately call the central station to prevent an unnecessary response.

Note: For CP-01 systems, the monitoring function must be enabled by the installer before it becomes functional. There is a communicator delay of 30 seconds in this control panel. It can be removed, or it can be increased up to 45 seconds, at the option of the end-user by consulting with the installer.

3.4 Maintenance

With normal use, the system requires minimum maintenance. Note the following points:

- Do not wash the security equipment with a wet cloth. Light dusting with a slightly moistened cloth should remove normal accumulations of dust.
- Use the system test described in “Testing Your System” to check the battery condition. We recommend, however, that the standby batteries be replaced every 3-5 years.
- For other system devices such as smoke detectors, passive infrared, ultrasonic or microwave motion detectors or glassbreak detectors, consult the manufacturer’s literature for testing and maintenance instructions.

4.0 Arming the System

The PowerSeries Neo system can be armed using a keypad, a 2-way wireless key or a proximity tag.

4.1 Arming the System (Infinite Exit Delay)

In an attempt to reduce false alarms, your system is designed to notify you of an improper exit when arming the system. When using the Push to Set, or Final Door Set feature, attempting to arm your system will start an infinite exit delay. The keypad will sound a beep once per second. When you have opened and closed the final exit door, or after pressing the Push to Set button, the exit delay will be reduced to a programmable value, which is typically 10 seconds, after which the alarm will complete the setting. The panel used this time period to allow time for the detectors on the system to return to their normal state. When this time expires, the system checks for detectors/windows/doors that may be open. If any of these are open, the panel will cancel the arming. If this occurs, you must re-enter the premises, check the system, close any open zones, and then attempt to arm again.

4.2 Away Arming the System with the Keypad

Away mode activates the complete alarm system by:



- Arming all perimeter sensors.
- Arming all interior sensors.

To Arm the System in Away Mode

1. Ensure all windows and doors are closed and that the Ready indicator is on.
2. To arm using the Away key , press and hold the Away key for 2 seconds and, if required, enter your [access code] or present your proximity tag.

OR

To Quick Arm the system press [*][0].

3. If zones have been bypassed, ICN or LED keypads bypass LED  will light and the bypassed zones #s will be shown. On an LCD keypad a warning appears.
4. After successfully initiating the arming sequence the:
 - Armed  indicator turns on.
 - Ready  indicator remains lit.
 - Exit Delay timer begins counting down.
 - Keypad beeps six times, continues beeping once per second until beeping rapidly in the final ten seconds.
 - The system may be configured to have a persistent exit delay that only ends when the exit door is opened and closed, or when a button is pressed outside the protected premises.

LCD Display

Date Time JAN 02/13 2:06a

System is Ready to Arm

then

Present Tag or Enter Code

* Warning *
Bypass Active

Exit Delay in Progress

5. To cancel the arming sequence, enter your [access code] or present your proximity tag to the keypad reader.
6. Once the exit delay timer expires, thereby arming the system, the:
 - Ready indicator turns off.
 - Armed indicator remains on.
 - Keypad stops sounding.

System Disarmed No Alarm Memory
System Armed in Away Mode

Note: The installer configures the exit delay timer and whether or not an access code is required for arming the system.

4.3 Exit Delay Time Restart

The control panel provides an option where, if a entry/exit zone is tripped a second time prior to the end of the exit delay, the exit delay time restarts. The exit delay timer can only be restarted once.

4.4 Alarm Cancel Window

The control panel provides a period of time in which the user can cancel the alarm transmission. If the programmed alarm transmission delay has expired, canceling an alarm sends a message to the monitoring station. Upon a successful transmission of the cancellation message the keypad will beep 6 times.

Note: Must be enabled and configured by installer.

Note: For CP-01 systems, alarm transmission delay must not exceed 45 seconds.

4.5 Using 2-way Wireless Keys and Proximity Tags

2-way wireless keys allow users in the close proximity of their house the ability to readily arm/disarm their system, and to call for help. For information on enrolling wireless keys see "User Labels (LCD keypads only)".

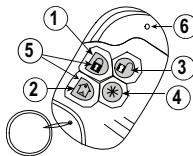
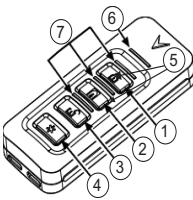

1. Away Arm
2. Stay Arm
3. Disarm
4. Panic
5. Command Output 1
6. Message LED
7. Status LEDs

1. Away Arm
2. Stay Arm
3. Disarm
4. Panic
5. Command Output 1
6. LED

Note: Panic feature has not been evaluated by UL. All wireless key buttons are programmable. Verify the functions assigned to each key with your installer. When using compatible wireless keys there is one bell squawk for arming and two bell squawks for disarming.

4.5.1 Arming the System with a 2-Way Wireless Key

If configured, the PowerSeries Neo system can be armed using the following wireless keys:

- PG4929/PG8929/PG9929
- PG4939/PG8939/PG9939

To Arm the System with a 2-way wireless key

- Press the desired Arming mode button anytime the system Ready indicator is on.

4.5.2 Arming the System with a Proximity Tag

Depending on how your keypad is programmed, proximity tags can be used to either arm/disarm the system or to perform a programmed function (e.g. unlock a cabinet or storeroom door).

To Arm the System with a Proximity tag

- Present your Proximity tag to a keypad equipped with a proximity sensor anytime the system Ready indicator is on.
- If configured by your installer, enter your access code.

4.6 Disarming the System

Depending on your system configuration, there are multiple methods you can use to disarm your system. You can disarm the system using a:

- 2-way wireless key
- Proximity tag

To Disarm the System with a Keypad

1. Enter your [access code] or present your proximity tag anytime the system is armed . (Armed  indicator is on).
2. If you walk through the entry door, the keypad will beep. Disarm within ____ seconds to avoid an alarm condition.

To Disarm the System with a 2-way Wireless Key

1. Press the disarm button anytime the system is armed. (Armed  indicator is on).
2. If you walk through the entry door the keypad will beep. Press the disarm button within ____ seconds to avoid an alarm condition.

Note: After disarming a system with an HS2LCD keypad using a 2-way wireless key, always check the alarm memory to determine if any alarms have occurred during the armed period.

To Disarm the System with a Proximity Tag

1. Present your proximity tag to a keypad equipped with a proximity sensor anytime the system is armed . (Armed  indicator is on) and if configured as required, enter your access code.
2. If you walk through the entry door the keypad will beep. Present your proximity tag within ____ seconds to avoid an alarm condition.

Note: Duration of Entry timer is programmed by installer. The installer will advise the maximum duration of entry delay that was programmed in the system. It cannot exceed 45 seconds.

4.6.1 Disarming Error

If your code is invalid, the system will not disarm and a 2-second error tone will sound. If this occurs, press [#] and re-enter your access code.

5.0 Emergency Keys

IMPORTANT: EMERGENCY USE ONLY!

Pressing both the emergency keys generates a Fire, Medical, or Panic Alarm, and alerts the monitoring station. e.g., to generate a medical alarm press both of the medical alarm keys for 2 seconds and the display on an LCD keypad will show Hold down keys for Med. Alarm. The keypad beeps to indicate that the alarm input has been accepted and sent to the monitoring station.



Fire Alarm



Medical Alarm



Panic Alarm

Note: Verify with your alarm company that your system is equipped with emergency keys.

Note: Fire keys can be disabled by the installer.

Note: Having an optional audio verification module installed in your system allows the monitoring station to open 2-way communication when notified of an alarm.

6.0 Access Code Types

The alarm system provides the following user access code types:

Code	Add User	Delete User	Arm	Disarm	Access Codes	User Functions	Installer
Master	All	All	Yes	Yes	Yes	Yes	No
User	No	No	Yes	Yes	No	No	No
Supervisor	All but Master	All but Master	Yes	Yes	Yes	Yes	No
Duress	No	No	Yes	Yes	No	No	No
One-time user	No	No	Yes	1/day	No	No	No

Installer and Master code are system codes that can be changed but not deleted. The other codes are user-defined and can be added or deleted as necessary. By default, access codes have the same partition and attribute programming as the code used to program them.

Note: When using 8-digit access codes, the minimum number of variations are:

- 2083333 for HS2016/HS2016-4
- 1388888 for HS2032
- 1052631 for HS2064/HS2128
- 200000 for HS2064 E
- 100000 for HS2128 E

Additionally, there are no disallowed codes.

Master Code By default the master code can access all partitions and can perform any keypad function. This code can be used to program all access codes, including the supervisor and duress codes. The master code is code # [01].

User Codes This type of access code is used to arm and disarm assigned partitions and can access the User Functions menu.

Supervisor Codes Use when you want to allow additional users to manage Access Codes [*5] or User Functions [*6]. Supervisor codes created by the master code will have the same attributes as the master code. Supervisor codes created by another supervisor code will have the same attributes, except the supervisor attribute. Must be assigned manually afterward. After creation, attributes can be changed for all supervisor codes. For information on how to program a supervisor code see "Configuring additional User Options".

Duress Codes Use if forced to access your keypad under threat. Duress codes function the same as user access codes, except they transmit a Duress Report to your monitoring station when used to perform any function on the system. Duress codes cannot be used to access Access Codes [*5], User Functions [*6] or Installer [*8] menus. For information on how to program a Duress Code see "Configuring additional User Options".

One Time User Code Used to grant someone one-time access to your home once per day, i.e., a cleaning person or contractor. The ability to disarm the system is reset at midnight or when the one-time user code is keyed in by the master code user. For information on how to program a One Time User Code see "Configuring Additional User Options".

To Open the Access Codes Menu

1. Press [*][5]

OR

press [*] and use the scroll keys to navigate to Access Codes and press [*].

2. Enter [Master or supervisor code].

Press (*) for <>
Access Codes

3. Enter [User #]

OR

scroll through the list of users and press [*]. On an LED keypad the user number will begin flashing.

Present Tag or
Enter Code

Press (*) for <>
{User Label}

4. To go back to the Ready state press [#].

6.1 Adding, Changing and Deleting Access Codes

Each configured user is assigned a number as follows:

- 01-48 for HS2016/HS2016-4
- 01-72 for HS2032
- 01-95 for HS2064/HS2128
- 001-500 for HS2064 E
- 0001-1000 for HS2128 E

Access codes cannot be duplicated.

To Add or Change User Access Codes

1. From the desired user press [*] or [1].
2. Enter a new 4, 6, or 8-digit access code. After entering a new code you will be automatically returned to the previous menu, and on an LCD display the flag is changed to P from -. On an ICN or LED keypad the programmed user will have their digits displayed. If a duplicate code is entered the error tone will sound. After the code is programmed, the keypad returns to the previous LCD display.

LCD Display

Press (*) for <>
Access Code

Enter New Code
AAAA

To Delete a User Access Code

1. From the desired user press [*] or [1].
2. Press [*]. The code is deleted, and you are returned to the previous screen. The flag is changed to - from P. On an ICN or LED keypad the programmed user's digits will cease being displayed. After the code is programmed, the keypad returns to the previous LCD display.

LCD Display

Press (*) for <>
Access Code

Enter New Code
030516

Note: Any proximity tags associated with deleted user codes will need to be re-enrolled.

6.2 Burglary Verification

The Control Panel includes cross zone and sequential detection features that require a trip on two or more zones within a given time period, to generate a confirmed alarm and immediate police response.

Note: Must be enabled and configured by installer.

6.3 Swinger Shutdown

The Control Panel has a swinger shutdown feature that when enabled a programmable number of trips shall shut down the zone. All burglary zone types have this feature enabled in CP-01 installations.

Note: Must be enabled and configured by installer.

6.4 Call Waiting

The Control Panel includes a programmable option for call waiting to prevent a call waiting line from interfering with the alarm verification process. This option is disabled by default.

Note: Must be enabled and configured by installer.

6.5 Fire Alarm Verification

Fire Alarm Verification is an available option for Fire zones. If configured, once the conditions for alarm verification are met the fire alarm will sound and an alarm transmission will be sent to the monitoring station.

Note: Must be enabled and configured by installer.

6.6 System Lockout due to Invalid Attempts

If too many invalid access codes are entered, your system can be configured to automatically lock out inputs from all keypads, wireless and proximity keys, and SMS commands for a specified duration. When any keys are pressed, an error tone will sound. FMP keys are still active during Keypad Lockout.

Note: Feature and lockout duration must be configured by installer.

6.7 User Labels (LCD keypads only)

Adding or editing labels is done by using a pre-programmed word library. The following table library lists the full library and the associated three digit code.

To Edit a User Label

1. From the applicable user, press [3] or use the scroll keys to scroll to User Labels and press [*].
2. Press [*] [*] to enter word library.
3. Use the scroll keys to scroll through the list of words or use the [3-digit number] to display the desired word. Press [*] to select the word.
4. To enter an additional word, repeat step 3.

LCD Display

Press (*) for <> User Labels

Program Name {User 1 Label 1}

Press (*) for {User Label}

Word Library											
#	Text	#	Text	#	Text	#	Text	#	Text	#	Text
001	Aborted	041	Communicator	081	Front	121	Memory	161	Screen	201	7
002	AC	042	Computer	082	Furnace	122	Menu	162	Second	202	8
003	Access	043	Control	083	Gallery	123	Monoxide	163	Sensor	203	9
004	Active	044	Date	084	Garage	124	Mother's	164	Service	204	A
005	Activity	045	Daughter's	085	Gas	125	Motion	165	Shed	205	B
006	Alarm	046	Degrees	086	Glass	126	No	166	Shock	206	C
007	All	047	Delay	087	Goodbye	127	North	167	Shop	207	D
008	AM	048	Den	088	Gym	128	Not	168	Side	208	E
009	Area	049	Desk	089	Hallway	129	Now	169	Siren	209	F
010	Arm	050	Detector	090	Heat	130	Number	170	Sliding	210	G
011	Armed	051	Dining	091	Hello	131	Off	171	Smoke	211	H
012	Arming	052	Disarmed	092	Help	132	Office	172	Son's	212	I
013	Attic	053	Door	093	High	133	OK	173	Sound	213	J
014	Auxiliary	054	Down	094	Home	134	On	174	South	214	K
015	Away	055	Download	095	House	135	Open	175	Special	215	L
016	Baby	056	Downstairs	096	In	136	Opening	176	Stairs	216	M
017	Back	057	Drawer	097	Install	137	Panic	177	Stay	217	N
018	Bar	058	Driveway	098	Interior	138	Partition	178	Sun	218	O
019	Basement	059	Duct	099	Intrusion	139	Patio	179	Supervisory	219	P
020	Bathroom	060	Duress	100	Invalid	140	Pet	180	System	220	Q
021	Battery	061	East	101	Is	141	Phone	181	Tamper	221	R
022	Bedroom	062	Energy	102	Key	142	Please	182	Temperature	222	S
023	Bonus	063	Enter	103	Kids	143	PM	183	Test	223	T
024	Bottom	064	Entry	104	Kitchen	144	Police	184	Time	224	U
025	Breezeway	065	Error	105	Latchkey	145	Pool	185	To	225	V
026	Building	066	Exercise	106	Laundry	146	Porch	186	Touchpad	226	W
027	Bus	067	Exit	107	Left	147	Power	187	Trouble	227	X
028	Bypass	068	Exterior	108	Level	148	Press	188	Unbypass	228	Y
029	Bypassed	069	Factory	109	Library	149	Program	189	Unit	229	Z
030	Cabinet	070	Failure	110	Light	150	Progress	190	Up	230	(Space)
031	Camera	071	Family	111	Lights	151	Quiet	191	West	231	'
032	Canceled	072	Father's	112	Living	152	Rear	192	Window	232	- (Dash)
033	Car	073	Feature	113	Load	153	Receiver	193	Zone	233	_
034	Carbon	074	Fence	114	Loading	154	Report	194	0	234	*
035	Central	075	Fire	115	Low	155	RF	195	1	235	#
036	Chime	076	First	116	Lower	156	Right	196	2	236	:
037	Closed	077	Floor	117	Main	157	Room	197	3	237	/
038	Closet	078	Force	118	Master	158	Safe	198	4	238	?
039	Closing	079	Foyer	119	Mat	159	Saver	199	5	239	
040	Code	080	Freeze	120	Medical	160	Schedule	200	6	240	

7.0 Trouble Conditions

Occasionally, you may have a problem with your Alarm Controller or telephone line. If this happens, your Alarm Controller identifies the problem and displays an error message. Refer to the provided list when you see an error message on the display. If additional help is required, contact your distributor for service.

Note: This equipment contains no user-serviceable parts, except for the keypad batteries. Dispose of used batteries as per local rules and regulations.

When the system detects a trouble condition the following occurs:

- The Trouble indicator turns on.
- The keypad beeps once every 10 seconds.
- Press the [*] key to silence the keypad beeps.

Press [*][2] to examine troubles. When viewing troubles, the trouble indicator flashes to identify the level of trouble being viewed. One flash = level 1, two flashes = level 2 etc.

Arming of your system may be impeded by a trouble. To override this condition, enter [*2], scroll to Acknowledge All Troubles and press [*] or enter 999.

Trouble Condition	Trouble		Trouble Types	Trouble Notification	
	# Level 1	Description		# Level 2	Level 3
Note: Trouble #s are used to identify the number to view the trouble and depending on the keypad type being used, identifies which LED or digit illuminates to display the trouble. Similarly, Trouble Notification identifies the range that may be displayed on the keypad. When exploring the trouble levels, the Trouble indicator will flash to identify which level you are currently viewing.					
Service Required	01	Assorted Trouble types. Time and Date troubles can be resolved by resetting the Time/Date. To set Time/Date press [*][6][0][1]. For all other troubles call for service.	Bell Circuit	01	
			RF Jam	02	
			Auxiliary Supply	03	
			Loss of clock	04	
			Output 1 Fault	05	

Trouble Condition	Trouble # Level 1	Description	Trouble Types	Trouble # Level 2	Trouble Notification Level 3
Battery Trouble	02	The system has detected a battery trouble condition. Call for service.	Low Battery (System Label)	01	n/a
			No Battery service (System Label)	02	n/a
			High Current Output Low Battery	04	Module 1-4
			High Current Output No Battery	05	Module 1-4
			Power Supply Low Battery	07	Module 1-4
			Power Supply No Battery	08	Power supply 1-4
Bus Voltage	03	A module has detected a low voltage on its corbus red terminal.	HSM2HOST	01	n/a
			Keypad	02	Keypad 1-16
			Zone Expander	04	Zone expander 1-15
			Power Supply	05	Power supply 1-4
			High Current Output	06	Output terminal 1-4
			Output Expander	08	Output module 1-16
			HSM2955 Bus Voltage (Audio Expander)	09	n/a
AC Troubles	04	The system is experiencing loss of power. Call for service. If the building and/or neighborhood has lost electrical power, the system will continue to operate on battery for several hours.	Zone	01	Zone label or 001-128
			Siren	03	Siren 1-16
			Repeater	04	Repeater 1-8
			Power Supply	05	Power supply 1-4
			High Current Output	06	Output terminal 1-4
			System Label	07	n/a

Trouble Condition	Trouble # Level 1	Description	Trouble Types	Trouble # Level 2	Trouble Notification Level 3
Device Faults	05	The system has detected an issue with one or more connected devices. Call for service.	Gas		
			Heat		
			CO		
			Freeze		
			Probe Dis-connected		
			Fire		
			Zone	01	Zone label or 001-128
			Keypad	02	Keypad 1-16
			Siren	03	Siren 1-16
			Repeater	04	Repeater 1-8
Device Battery	06	The system has detected an issue with one or more of the device batteries. For Zone, Keypad and Wireless Key battery troubles see the accompanying documentation for how to change the batteries.	Zone	01	Zone label or 001-128
			Keypad	02	Keypad 1-16
			Siren	03	Siren 1-16
			Repeater	04	Repeater 1-8
			User	05	Wireless key 1-32
Device Tamper	07	The system has detected a tamper condition with one or more devices on the system. Call for service.	Zone	01	Zone label or 001-128
			Keypad	02	Keypad 1-16
			Siren	03	Siren 1-16
			Repeater	04	Repeater 1-8
			Audio Station	05	Audio Station 1-4
RF Delinquency	08	The system has detected wireless signal interference that is causing improper system operation. Call for service.	Zones	01	Zone label or 001-128
			Keypad	02	Keypad 1-16
			Siren	03	Siren 1-16
			Repeater	04	Repeater 1-8

Trouble Condition	Trouble # Level 1	Description	Trouble Types	Trouble # Level 2	Trouble Notification Level 3
Module Supervision	09	The system has detected a supervisory trouble condition with one or more modules on the system. Call for service.	HSM2HOST	01	n/a
			Keypad	02	Keypad 1-16
			Zone Expander	04	Zone Expander 1-15
			Power Supply	05	Power supply 1-4
			High Current Output	06	Output terminal 1-4
			Output Expander	08	Output module 1-16
			Audio Expander	09	n/a
Module Tamper	10	The system has detected a tamper condition with one or more modules on the system. Call for service.	HSM2HOST	01	n/a
			Keypad	02	Keypad 1-16
			Zone Expander	04	Zone Expander 1-15
			Power Supply	05	Power supply 1-4
			High Current Output	06	Output terminal 1-4
			Output Expander	08	Output module 1-16
			Audio Expander	09	n/a
			Alt. Comm	10	n/a
Communications	11	The system has detected a communication trouble. Call for service.	TLM Trouble	01	n/a
			FTC Trouble	02	Receiver 1-4
			SIM Lock	03	n/a
			Cellular	04	n/a
			Ethernet	05	n/a
			Receiver	06	Receiver 1-4
			Supervision Receiver	07	Receiver 1-4
			Alt Comm Fault	09	n/a
			Alt Comm FTC	10	Receiver 1-4

Trouble Condition	Trouble # Level 1	Description	Trouble Types	Trouble # Level 2	Trouble Notification Level 3
Not Networked	12	The system has detected a network trouble condition with one or more modules on the system. If the trouble does not restore within 20 minutes, call for service.	Zone	01	Zone label 001-128
			Keypad	02	Keypad 1-16
			Siren	03	Siren 1-16
			Repeater	04	Repeater 1-8
			User	05	Users 01-1000

8.0 Safety Instructions

This equipment is stationary-fixed and must be installed by Service Persons only (Service Person is defined as a person having the appropriate technical training and experience necessary to be aware of hazards to which that person may be exposed in performing a task and of measures to minimize the risks to that person or other persons). It must be installed and used within an environment that provides the pollution degree max 2, over voltages category II, in non-hazardous, indoor locations only.

WARNING! When using equipment connected to the mains and/or to the telecommunication network, there are basic safety instructions that should always be followed. Refer to the safety instructions provided with this product and save them for future reference. To reduce the risk of fire, electric shock and/or injury, observe the following:

- Do not attempt to service this product yourself. Opening or removing the cover may expose you to dangerous voltage or other risk. Refer servicing to service persons. Never open the device yourself.
- Use authorized accessories only with this equipment.
- DO NOT leave and/or deposit ANY object on the top of the cabinet of this equipment! The cabinet as it is installed on the wall is not designed to support any supplementary weight!
- Do not spill any liquids on the cabinet.
- Do not touch the equipment and its connected cables during an electrical storm; there may be a risk of electric shock.
- Never touch uninsulated wires or terminals unless the equipment has been disconnected from the mains supply and from the telecommunication network!
- Ensure that cables are positioned so that accidents cannot occur. Connected cables must not be subject to excessive mechanical strain. Do not spill any type of liquid on the equipment.
- Do not use the Alarm system to report a gas leak if the system is near a leak.
- Do not subject the connected cables to an excessive mechanical strain.

These safety instructions should not prevent you from contacting the distributor and/or the manufacturer to obtain any further clarification and/or answers to your concerns.

8.1 Regular Maintenance and Troubleshooting

Keep your Alarm Controller in optimal condition by following all the instructions that are included within this manual and/or marked on the product. It is the end-user and/or installer's responsibility to ensure that the disposal of the used batteries is made according to the waste recovery and recycling regulations applicable to the intended market.

8.1.1 Cleaning and Maintenance

- Clean the units by wiping with a damp cloth only.
- Do not wipe the front cover with alcohol.
- Do not use any water or any other liquid.
- Do not use abrasives, thinners, solvents or aerosol cleaners (spray polish) that may enter through holes in the Alarm Controller and cause damage.
- Use the system test described in "Testing Your System" to check the battery condition. We recommend, however, that the standby batteries be replaced every 3-5 years.

- For other system devices such as smoke detectors, passive infrared, ultrasonic or microwave motion detectors or glassbreak detectors, consult the manufacturer's literature for testing and maintenance instructions.

This publication covers the following models: x = 9 (912-919MHz UL/ULC systems) 4 (433MHz) or 8 (868MHz).

- | | | | |
|------------|------------|---------------|--------------|
| • HS2016 | • HS2128 | • HS2LCDRF | • HS2LED |
| • HS2016-4 | • HS2128 E | • HS2LCDRFPx | • HS2ICN |
| • HS2032 | • HS2TCHP | • HS2LCDWFX | • HS2ICNP |
| • HS2064 | • HS2LCD | • HS2LCDWFPx | • HS2ICNRFx |
| • HS2064 E | • HS2LCDP | • HS2LCDWFPVx | • HS2ICNRFPx |

9.0 EULA

IMPORTANT - READ CAREFULLY: DSC Software purchased with or without Products and Components is copyrighted and is purchased under the following license terms:

This End-User License Agreement (“EULA”) is a legal agreement between You (the company, individual or entity who acquired the Software and any related Hardware) and Digital Security Controls, a division of Tyco Safety Products Canada Ltd. (“DSC”), the manufacturer of the integrated security systems and the developer of the software and any related products or components (“HARDWARE”) which You acquired.

If the DSC software product (“SOFTWARE PRODUCT”) or “SOFTWARE”) is intended to be accompanied by HARDWARE, and is NOT accompanied by new HARDWARE, You may not use, copy or install the SOFTWARE PRODUCT. The SOFTWARE PRODUCT includes computer software, and may include associated media, printed materials, and “online” or electronic documentation. Any software provided along with the SOFTWARE PRODUCT that is associated with a separate end-user license agreement is licensed to You under the terms of that license agreement.

By installing, copying, downloading, storing, accessing or otherwise using the SOFTWARE PRODUCT, You agree unconditionally to be bound by the terms of this EULA, even if this EULA is deemed to be a modification of any previous arrangement or contract. If You do not agree to the terms of this EULA, DSC is unwilling to license the SOFTWARE PRODUCT to You, and You have no right to use it.

SOFTWARE PRODUCT LICENSE

The SOFTWARE PRODUCT is protected by copyright laws and international copyright treaties, as well as other intellectual property laws and treaties. The SOFTWARE PRODUCT is licensed, not sold.

1. GRANT OF LICENSE This EULA grants You the following rights:

- (a) **Software Installation and Use** - For each license You acquire, You may have only one copy of the SOFTWARE PRODUCT installed.
- (b) **Storage/Network Use** - The SOFTWARE PRODUCT may not be installed, accessed, displayed, run, shared or used concurrently on or from different computers, including a workstation, terminal or other digital electronic device (“Device”). In other words, if You have several workstations, You will have to acquire a license for each workstation where the SOFTWARE will be used.
- (c) **Backup Copy** - You may make back-up copies of the SOFTWARE PRODUCT, but You may only have

one copy per license installed at any given time. You may use the back-up copy solely for archival purposes. Except as expressly provided in this EULA, You may not otherwise make copies of the SOFTWARE PRODUCT, including the printed materials accompanying the SOFTWARE.

2. DESCRIPTION OF OTHER RIGHTS AND LIMITATIONS

(a) **Limitations on Reverse Engineering, Decompilation and Disassembly** - You may not reverse engineer, decompile, or disassemble the SOFTWARE PRODUCT, except and only to the extent that such activity is expressly permitted by applicable law notwithstanding this limitation. You may not make any changes or modifications to the Software, without the written permission of an officer of DSC. You may not remove any proprietary notices, marks or labels from the Software Product. You shall institute reasonable measures to ensure compliance with the terms and conditions of this EULA.

(b) **Separation of Components** - The SOFTWARE PRODUCT is licensed as a single product. Its component parts may not be separated for use on more than one HARDWARE unit.

(c) **Single INTEGRATED PRODUCT** - If You acquired this SOFTWARE with HARDWARE, then the SOFTWARE PRODUCT is licensed with the HARDWARE as a single integrated product. In this case, the SOFTWARE PRODUCT may only be used with the HARDWARE as set forth in this EULA.

(d) **Rental** - You may not rent, lease or lend the SOFTWARE PRODUCT. You may not make it available to others or post it on a server or web site.

(e) **Software Product Transfer** - You may transfer all of Your rights under this EULA only as part of a permanent sale or transfer of the HARDWARE, provided You retain no copies, You transfer all of the SOFTWARE PRODUCT (including all component parts, the media and printed materials, any upgrades and this EULA), and provided the recipient agrees to the terms of this EULA. If the SOFTWARE PRODUCT is an upgrade, any transfer must also include all prior versions of the SOFTWARE PRODUCT.

(f) **Termination** - Without prejudice to any other rights, DSC may terminate this EULA if You fail to comply with the terms and conditions of this EULA. In such event, You must destroy all copies of the SOFTWARE PRODUCT and all of its component parts.

(g) **Trademarks** - This EULA does not grant You any rights in connection with any trademarks or service marks of DSC or its suppliers.

3. COPYRIGHT - All title and intellectual property rights in and to the SOFTWARE PRODUCT (including but not limited to any images, photographs, and

text incorporated into the SOFTWARE PRODUCT), the accompanying printed materials, and any copies of the SOFTWARE PRODUCT, are owned by DSC or its suppliers. You may not copy the printed materials accompanying the SOFTWARE PRODUCT. All title and intellectual property rights in and to the content which may be accessed through use of the SOFTWARE PRODUCT are the property of the respective content owner and may be protected by applicable copyright or other intellectual property laws and treaties. This EULA grants You no rights to use such content. All rights not expressly granted under this EULA are reserved by DSC and its suppliers.

4. EXPORT RESTRICTIONS - You agree that You will not export or re-export the SOFTWARE PRODUCT to any country, person, or entity subject to Canadian export restrictions.

5. CHOICE OF LAW - This Software License Agreement is governed by the laws of the Province of Ontario, Canada.

6. ARBITRATION - All disputes arising in connection with this Agreement shall be determined by final and binding arbitration in accordance with the Arbitration Act, and the parties agree to be bound by the arbitrator's decision. The place of arbitration shall be Toronto, Canada, and the language of the arbitration shall be English.

7. LIMITED WARRANTY

(a) NO WARRANTY - DSC PROVIDES THE SOFTWARE "AS IS" WITHOUT WARRANTY. DSC DOES NOT WARRANT THAT THE SOFTWARE WILL MEET YOUR REQUIREMENTS OR THAT OPERATION OF THE SOFTWARE WILL BE UNINTERRUPTED OR ERROR-FREE.

(b) CHANGES IN OPERATING ENVIRONMENT - DSC shall not be responsible for problems caused by changes in the operating characteristics of the HARDWARE, or for problems in the interaction of the SOFTWARE PRODUCT with non-DSC-SOFTWARE or HARDWARE PRODUCTS.

(c) LIMITATION OF LIABILITY; WARRANTY REFLECTS ALLOCATION OF RISK - IN ANY EVENT, IF ANY STATUTE IMPLIES WARRANTIES OR CONDITIONS NOT STATED IN THIS LICENSE AGREEMENT, DSC'S ENTIRE LIABILITY UNDER ANY PROVISION OF THIS LICENSE AGREEMENT SHALL BE LIMITED TO THE GREATER OF THE AMOUNT ACTUALLY PAID BY YOU TO LICENSE THE SOFTWARE PRODUCT AND FIVE CANADIAN DOLLARS (CAD\$5.00). BECAUSE SOME JURISDICTIONS DO NOT ALLOW THE EXCLUSION OR LIMITATION OF LIABILITY FOR CONSEQUENTIAL OR INCIDENTAL DAMAGES,

THE ABOVE LIMITATION MAY NOT APPLY TO YOU.

(d) DISCLAIMER OF WARRANTIES - THIS WARRANTY CONTAINS THE ENTIRE WARRANTY AND SHALL BE IN LIEU OF ANY AND ALL OTHER WARRANTIES, WHETHER EXPRESSED OR IMPLIED (INCLUDING ALL IMPLIED WARRANTIES OF MERCHANTABILITY OR FITNESS FOR A PARTICULAR PURPOSE) AND OF ALL OTHER OBLIGATIONS OR LIABILITIES ON THE PART OF DSC. DSC MAKES NO OTHER WARRANTIES. DSC NEITHER ASSUMES NOR AUTHORIZES ANY OTHER PERSON PURPORTING TO ACT ON ITS BEHALF TO MODIFY OR TO CHANGE THIS WARRANTY, NOR TO ASSUME FOR IT ANY OTHER WARRANTY OR LIABILITY CONCERNING THIS SOFTWARE PRODUCT.

(e) EXCLUSIVE REMEDY AND LIMITATION OF WARRANTY - UNDER NO CIRCUMSTANCES SHALL DSC BE LIABLE FOR ANY SPECIAL, INCIDENTAL, CONSEQUENTIAL OR INDIRECT DAMAGES BASED UPON BREACH OF WARRANTY, BREACH OF CONTRACT, NEGLIGENCE, STRICT LIABILITY, OR ANY OTHER LEGAL THEORY. SUCH DAMAGES INCLUDE, BUT ARE NOT LIMITED TO, LOSS OF PROFITS, LOSS OF THE SOFTWARE PRODUCT OR ANY ASSOCIATED EQUIPMENT, COST OF CAPITAL, COST OF SUBSTITUTE OR REPLACEMENT EQUIPMENT, FACILITIES OR SERVICES, DOWN TIME, PURCHASERS TIME, THE CLAIMS OF THIRD PARTIES, INCLUDING CUSTOMERS, AND INJURY TO PROPERTY. WARNING: DSC recommends that the entire system be completely tested on a regular basis. However, despite frequent testing, and due to, but not limited to, criminal tampering or electrical disruption, it is possible for this SOFTWARE PRODUCT to fail to perform as expected.

Always ensure you obtain the latest version of the User Guide. Updated versions of this User Guide are available by contacting your distributor.

10.0 Installer Warning

Warning Please Read Carefully

Note To Installers:

This warning contains vital information. As the only individual in contact with system users, it is your responsibility to bring each item in this warning to the attention of the users of this system.

System Failures

This system has been carefully designed to be as effective as possible. There are circumstances, however, involving fire, burglary, or other types of emergencies where it may not provide protection. Any alarm system of any type may be compromised deliberately or may fail to operate as expected for a variety of reasons. Some but not all of these reasons may be:

Inadequate Installation

A security system must be installed properly in order to provide adequate protection. Every installation should be evaluated by a security professional to ensure that all access points and areas are covered. Locks and latches on windows and doors must be secure and operate as intended. Windows, doors, walls, ceilings and other building materials must be of sufficient strength and construction to provide the level of protection expected. A reevaluation must be done during and after any construction activity. An evaluation by the fire and/or police department is highly recommended if this service is available.

Criminal Knowledge

This system contains security features which were known to be effective at the time of manufacture. It is possible for persons with criminal intent to develop techniques which reduce the effectiveness of these features. It is important that a security system be reviewed periodically to ensure that its features remain effective and that it be updated or replaced if it is found that it does not provide the protection expected.

Access by Intruders

Intruders may enter through an unprotected access point, circumvent a sensing device, evade detection by moving through an area of insufficient coverage, disconnect a warning device, or interfere with or prevent the proper operation of the system.

Power Failure

Control units, intrusion detectors, smoke detectors and many other security devices require an adequate power supply for proper operation. If a device operates from batteries, it is possible for the batteries to fail. Even if the batteries have not failed, they must be charged, in good condition and installed correctly. If a device operates only by AC power, any interruption, however brief, will render that device inoperative while it does not have power. Power interruptions of any length are often accompanied by voltage fluctuations which may damage electronic equipment such as a security system. After a power interruption has occurred, immediately conduct a complete system test to ensure that the system operates as intended.

Failure of Replaceable Batteries

This system's wireless transmitters have been designed to provide several years of battery life under normal conditions. The expected battery life is a function of the device environment, usage and type. Ambient conditions such as high humidity, high or low temperatures, or large temperature fluctuations may reduce the expected battery life. While each transmitting device has a low battery monitor which identifies when the batteries need to be replaced, this monitor may fail to operate as expected. Regular testing and maintenance will keep the system in good operating condition.

Compromise of Radio Frequency (Wireless)

Devices

Signals may not reach the receiver under all circumstances which could include metal objects placed on or near the radio path or deliberate jamming or other inadvertent radio signal interference.

System Users

A user may not be able to operate a panic or emergency switch possibly due to permanent or temporary physical disability, inability to reach the device in time, or unfamiliarity with the correct operation. It is important that all system users be trained in the correct operation of the alarm system and that they know how to respond when the system indicates an alarm.

Smoke Detectors

Smoke detectors that are a part of this system may not properly alert occupants of a fire for a number of reasons, some of which follow. The smoke detectors may have been improperly installed or positioned. Smoke may not be able to reach the smoke detectors, such as when the fire is in a chimney, walls or roofs, or on the other side of closed doors. Smoke detectors may not detect smoke from fires on another level of the residence or building. Every fire is different in the amount of smoke produced and the rate of burning. Smoke detectors cannot sense all types of fires equally well. Smoke detectors may not provide timely warning of fires caused by carelessness or safety hazards such as smoking in bed, violent explosions, escaping gas, improper storage

of flammable materials, overloaded electrical circuits, children playing with matches or arson.

Even if the smoke detector operates as intended, there may be circumstances when there is insufficient warning to allow all occupants to escape in time to avoid injury or death.

Motion Detectors

Motion detectors can only detect motion within the designated areas as shown in their respective installation instructions. They cannot discriminate between intruders and intended occupants. Motion detectors do not provide volumetric area protection. They have multiple beams of detection and motion can only be detected in unobstructed areas covered by these beams. They cannot detect motion which occurs behind walls, ceilings, floor, closed doors, glass partitions, glass doors or windows. Any type of tampering whether intentional or unintentional such as masking, painting, or spraying of any material on the lenses, mirrors, windows or any other part of the detection system will impair its proper operation.

Passive infrared motion detectors operate by sensing changes in temperature. However their effectiveness can be reduced when the ambient temperature rises near or above body temperature or if there are intentional or unintentional sources of heat in or near the detection area. Some of these heat sources could be heaters, radiators, stoves, barbecues, fireplaces, sunlight, steam vents, lighting and so on.

Warning Devices

Warning devices such as sirens, bells, horns, or strobes may not warn people or waken someone sleeping if there is an intervening wall or door. If warning devices are located on a different level of the residence or premise, then it is less likely that the occupants will be alerted or awakened. Audible warning devices may be interfered with by other noise sources such as stereos, radios, televisions, air conditioners or other appliances, or passing traffic. Audible warning devices, however loud, may not be heard by a hearing-impaired person.

Telephone Lines

If telephone lines are used to transmit alarms, they may be out of service or busy for certain periods of time. Also an intruder may cut the telephone line or defeat its operation by more sophisticated means which may be difficult to detect.

Insufficient Time

There may be circumstances when the system will operate as intended, yet the occupants will not be protected from the emergency due to their inability to respond to the warnings in a timely manner. If the system is monitored, the response may not occur in time to protect the occupants or their belongings.

Component Failure

Although every effort has been made to make this system as reliable as possible, the system may fail to function as intended due to the failure of a component.

Inadequate Testing

Most problems that would prevent an alarm system from operating as intended can be found by regular testing and maintenance. The complete system should be tested weekly and immediately after a break-in, an attempted break-in, a fire, a storm, an earthquake, an accident, or any kind of construction activity inside or outside the premises. The testing should include all sensing devices, keypads, consoles, alarm indicating devices and any other operational devices that are part of the system.

Security and Insurance

Regardless of its capabilities, an alarm system is not a substitute for property or life insurance. An alarm system also is not a substitute for property owners, renters, or other occupants to act prudently to prevent or minimize the harmful effects of an emergency situation.

GENERAL WARNING

The following is a list of warnings applicable when this equipment is connected to the New Zealand Telecom Network. The grant of a Telepermit for any item of terminal equipment indicates only that Telecom has accepted that the item complies with minimum conditions for connection to its network. It indicates no endorsement of the product by Telecom, nor does it provide any sort of warranty. Above all, it provides no assurance that any item will work correctly in all respects with another item of Telepermitted equipment of a different make or model, nor does it imply that any product is compatible with all of Telecom's network services.

Reverse Numbering (Decadic Signalling)

Decadic signaling should not be used as it is being progressively phased out of the network. DTMF dialing is 100% available and it should always be used.

Line Grabbing Equipment

This equipment is set up to carry out test calls at pre-determined times. Such test calls will interrupt any other calls that may be set up on the line at the same time. The timing set for such test calls should be discussed with the installer. The timing set for test calls from this equipment may be subject to 'drift'. If this proves to be inconvenient and your calls are interrupted, then the problem of timing should be discussed with the equipment installer. The matter should NOT be reported as a fault to Telecom Faults Service.

D.C. Line Feed To Other Devices

During dialing, this device unit does not provide DC voltage to the series port connection and this may cause loss of memory functions for the terminal devices (local telephone) connected to T-1, R-1.

General Operation (ringer sensitivity and loading)

This device only responds to Distinctive Alert cadences DA1 and DA2.

In the event of any problem with this device, it is to be disconnected. A CPE item connected to one of the device's terminal ports may be connected directly in its place. The user should then arrange for the product to be repaired. Should the matter be reported to Telecom as a wiring fault, and the fault is proven to be due to this product, a call-out charge will be incurred.

11.0 Reference Sheets

Fill out the following information for future reference and store this guide in a safe place.

11.1 System Information

Mark if Buttons are Enabled

[F] FIRE [M] Medical [P] PANIC

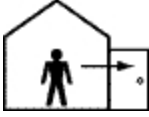

The Exit Delay Time is _____ seconds.

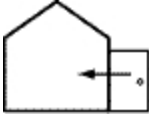

The Entry Delay Time is _____ seconds.

11.2 Service Contact Information

Central Station Information

Account #: _____ Telephone #: _____

Installer Information:

Company: _____ Telephone #: _____

Battery Installation / Service Date:

IMPORTANT: If you suspect a false alarm signal has been sent to the central monitoring station, call the station to avoid an unnecessary response.

12.0 Access Code and Sensor/Zone information

Master Code [01] : _____

Access Code Reference Sheet

Code	Access Code	Code	Access Code	Code	Access Code	Code	Access Code
01		02		03		04	
05		06		07		08	
09		10		11		12	
13		14		15		16	
17		18		19		20	
21		22		23		24	
25		26		27		28	
29		30		31		32	
33		34		35		36	
37		38		39		40	
41		42		43		44	
45		46		47		48	
49		50		51		52	
53		54		55		56	
57		58		59		60	
61		62		63		64	
65		66		67		68	
69		70		71		72	
73		74		75		76	
77		78		79		80	
81		82		83		84	
85		86		87		88	
89		90		91		92	
93		94		95			

Note: Copy this page as needed to record additional access codes.

Sensor/Zone Information

Sensor	Protected Area	Sensor Type	Sensor	Protected Area	Sensor Type
01			02		
03			04		
05			06		
07			08		
09			10		
11			12		
13			14		
15			16		
17			18		
19			20		
21			22		
23			24		
25			26		
27			28		
29			30		
31			32		
33			34		
35			36		
37			38		
39			40		
41			42		
43			44		
45			46		
47			48		
49			50		
51			52		
53			54		
55			56		
57			58		
59			60		
61			62		
63			64		
65			66		
67			68		
69			70		
71			72		
73			74		

Sensor	Protected Area	Sensor Type	Sensor	Protected Area	Sensor Type
75			76		
77			78		
79			80		
81			82		
83			84		
85			86		
87			88		
89			90		
91			92		
93			94		
95			96		
97			98		
99			100		
101			102		
103			104		
105			106		
107			108		
109			110		
111			112		
113			114		
115			116		
117			118		
119			120		
121			122		
123			124		
125			126		
127			128		

13.0 Locating Detectors and Escape Plan

The following information is for general guidance only and it is recommended that local fire codes and regulations be consulted when locating and installing smoke and CO alarms.

13.1 Smoke Detectors

Research has shown that all hostile fires in homes generate smoke to a greater or lesser extent. Experiments with typical fires in homes indicate that detectable quantities of smoke precede detectable levels of heat in most cases. For these reasons, smoke alarms should be installed outside of each sleeping area and on each storey of the home.

The following information is for general guidance only and it is recommended that local fire codes and regulations be consulted when locating and installing smoke alarms.

It is recommended that additional smoke alarms beyond those required for minimum protection be installed. Additional areas that should be protected include: the basement; bedrooms, especially where smokers sleep; dining rooms; furnace and utility rooms; and any hallways not protected by the required units. On smooth ceilings, detectors may be spaced 9.1m (30 feet) apart as a guide. Other spacing may be required depending on ceiling height, air movement, the presence of joists, uninsulated ceilings, etc. Consult National Fire Alarm Code NFPA 72, CAN/ULC-S553-02 or other appropriate national standards for installation recommendations.

- Do not locate smoke detectors at the top of peaked or gabled ceilings; the dead air space in these locations may prevent the unit from detecting smoke.
- Avoid areas with turbulent air flow, such as near doors, fans or windows. Rapid air movement around the detector may prevent smoke from entering the unit.
- Do not locate detectors in areas of high humidity.
- Do not locate detectors in areas where the temperature rises above 38°C (100°F) or falls below 5°C (41°F).
- Smoke detectors should always be installed in USA in accordance with Chapter 11 of NFPA 72, the National Fire Alarm Code: 11.5.1.1.

Where required by applicable laws, codes, or standards for a specific type of occupancy, approved single- and multiple-station smoke alarms shall be installed as follows:

1. In all sleeping rooms and guest rooms.
2. Outside of each separate dwelling unit sleeping area, within 6.4 m (21 ft) of any door to a sleeping room, the distance measured along a path of travel.
3. On every level of a dwelling unit, including basements.
4. On every level of a residential board and care occupancy (small facility), including basements and excluding crawl spaces and unfinished attics.
5. In the living area(s) of a guest suite.
6. In the living area(s) of a residential board and care occupancy (small facility).

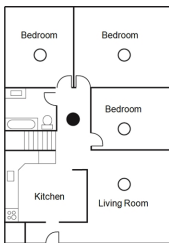

Figure 1

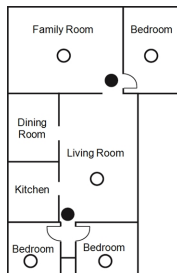

Figure 2

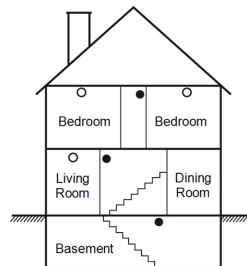

Figure 3

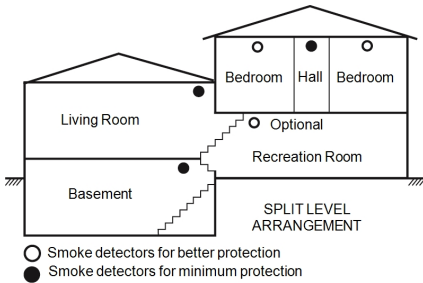

Figure 3a

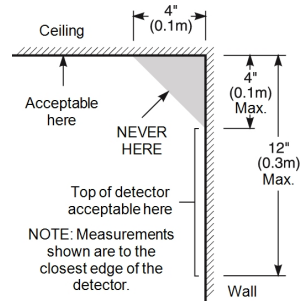

Figure 4

13.2 Fire Escape Planning

There is often very little time between the detection of a fire and the time it becomes deadly. It is thus very important that a family escape plan be developed and rehearsed.

1. Every family member should participate in developing the escape plan.
2. Study the possible escape routes from each location within the house. Since many fires occur at night, special attention should be given to the escape routes from sleeping quarters.
3. Escape from a bedroom must be possible without opening the interior door.

Consider the following when making your escape plans:

- Make sure that all border doors and windows are easily opened. Ensure that they are not painted shut, and that their locking mechanisms operate smoothly.
- If opening or using the exit is too difficult for children, the elderly or handicapped, plans for rescue should be developed. This includes making sure that those who are to perform the rescue can promptly hear the fire warning signal.
- If the exit is above the ground level, an approved fire ladder or rope should be provided as well as training in its use.
- Exits on the ground level should be kept clear. Be sure to remove snow from exterior patio doors in winter; outdoor furniture or equipment should not block exits.
- Each person should know the predetermined assembly point where everyone can be accounted for (e.g., across the street or at a neighbor's house). Once everyone is out of the building, call the fire department.
- A good plan emphasizes quick escape. Do not investigate or attempt to fight the fire, and do not gather belongings as this can waste valuable time. Once outside, do not re-enter the house. Wait for the fire department.
- Write the fire escape plan down and rehearse it frequently so that should an emergency arise, everyone will know what to do. Revise the plan as conditions change, such as the number of people in the home, or if there are changes to the building's construction.
- Make sure your fire warning system is operational by conducting weekly tests. If you are unsure about system operation, contact your installer.

We recommend that you contact your local fire department and request further information on fire safety and escape planning. If available, have your local fire prevention officer conduct an in-house fire safety inspection.

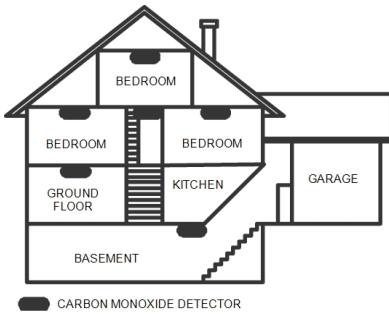

Figure 5

13.3 Carbon Monoxide Detectors

Carbon monoxide is colorless, odorless, tasteless, and very toxic, it also moves freely in the air. CO detectors can measure the concentration and sound a loud alarm before a potentially harmful level is reached. The human body is most vulnerable to the effects of CO gas during sleeping hours; therefore, CO detectors should be located in or as near as possible to sleeping areas of the home. For maximum protection, a CO alarm should be located outside primary sleeping areas or on each level of your home. Figure 5 indicates the suggested locations in the home.

Do NOT place the CO alarm in the following areas:

- Where the temperature may drop below -10°C or exceed 40°C
- Near paint thinner fumes
- Within 5 feet (1.5m) of open flame appliances such as furnaces, stoves and fireplaces
- In exhaust streams from gas engines, vents, flues or chimneys
- Do not place in close proximity to an automobile exhaust pipe; this will damage the detector

PLEASE REFER TO THE CO DETECTOR INSTALLATION AND OPERATING INSTRUCTION SHEET FOR SAFETY INSTRUCTIONS AND EMERGENCY INFORMATION.

14.0 Regulatory Agency Statements

CE Compliance Statement

This Product is in Conformity with EMC Directive 2004/108/EC based on results using harmonized standards in accordance with article 10(5), R&TTE Directive 1999/5/EC based on Following Annex III of the directive and LVD directive 2006/95/EC based on results using Harmonized standards.

EN50131 Compliance Statement

This product meets the requirements of Class II, Grade 2 equipment as per EN50131-1:2006+A1:2009, EN50131-3:2009, EN50131-6:2008 (Type A), EN50136-1-1:1997, EN50136-2-1, EN50136-2-3 (ATS2) Standards. This device is suitable for use in systems with the following notification options.

-A (use of two warning devices and internal dialer required)

-B (self-powered warning device and internal dialer required)

-C (use of DSC compatible alternate communicator in back-up or redundant mode)

-D (use of DSC compatible alternate communicator with encryption enabled required.)

Note: For EN50131 compliant installations only the intrusion portion of the alarm system has been investigated. Fire Alarm and Auxiliary (Medical) Alarm functions were not included in the evaluation of this product under the requirements of the above mentioned standards.

The model HS2128, HS2064, HS2032, HS2016 Control Panel has been certified by Telefication according to EN50131-1:2006 +A1:2009, EN50131-3:2009, EN50131-6:2008 (Type A) and EN50136-1:1997 (ATS2) for Grade 2, Class II.

UK Compliance Statement

In the UK this product is suitable for use in systems installed to conform to PD 6662:2010 at Grade 2 and environmental class 2 with the following notification options: A, B, C, D, X

Hereby, DSC, declares that this device is in compliance with the essential requirements and other relevant provisions of Directive 1999/5/EC.

The complete R&TTE Declaration of Conformity can be found at http://www.dsc.com/listings_index.aspx

(CZE) DSC jako výrobce prohlašuje, že tento výrobek je v souladu se všemi relevantními požadavky směrnice 1999/5/EC.

(DAN) DSC erklærer herved at denne komponent overholder alle vigtige krav samt andre bestemmelser gældende i direktiv 1999/5/EC.

(DUT) Hierbij verklaart DSC dat dit toestel in overeenstemming is met de eisen en bepalingen van richtlijn 1999/5/EC.

(FIN) DSC vakuuttaa laitteen täyttävän direktiivin 1999/5/EC olennaiset vaatimukset.

(FRE) Par la présente, DSC déclare que ce dispositif est conforme aux exigences essentielles et autres stipulations pertinentes de la Directive 1999/5/EC.

(GER) Hierdurch erklärt DSC, daß dieses Gerät den erforderlichen Bedingungen und Voraussetzungen der Richtlinie 1999/5/EC entspricht.

(GRE) Δια του παρόντος, η DSC, δηλώνει ότι αυτή η συσκευή είναι σύμφωνη με τις ουσιαστικές απαιτήσεις και με άλλες τις άλλες σχετικές αναφορές της Οδηγίας 1999/5/EC.

(ITA) Con la presente la Digital Security Controls dichiara che questo prodotto è conforme ai requisiti essenziali ed altre disposizioni rilevanti relative alla Direttiva 1999/05/CE.

(NOR) DSC erklærer at denne enheten er i samsvar med de grunnleggende krav og øvrige relevante krav i direktiv 1999/5/EF.

(POL) DSC oświadcza, że urządzenie jest w zgodności z zasadniczymi wymaganiami oraz pozostałymi stosownymi postanowieniami Dyrektywy 1999/5/WE.

(POR) Por este meio, a DSC, declara que este equipamento está em conformidade com os requisitos essenciais e outras determinações relevantes da Directiva 1999/5/EC.

(SPA) Por la presente, DSC, declara que este equipo está en conformidad con los requisitos esenciales y otros requisitos relevantes de la Directiva 1999/5/EC.

(SWE) DSC bekräftar härmed att denna apparat uppfyller de väsentliga kraven och andra relevanta bestämmelser i Direktivet 1999/5/EC.



© 2016 Tyco Security Products. All Rights Reserved.
Tech Support: 905-760-3000
• www.dsc.com

The trademarks, logos, and service marks displayed on this document are registered in the United States [or other countries]. Any misuse of the trademarks is strictly prohibited and Tyco Security Products will aggressively enforce its intellectual property rights to the fullest extent of the law, including pursuit of criminal prosecution wherever necessary. All trademarks not owned by Tyco Security Products are the property of their respective owners, and are used with permission or allowed under applicable laws.

Product offerings and specifications are subject to change without notice. Actual products may vary from photos. Not all products include all features. Availability varies by region; contact your sales representative.

DSC

From Tyco Security Products



29009539R001